



## INSTALL GUIDE

### OEM-CH(RS)-CH5-[FLRSCH5]-EN

**DOCUMENT NUMBER**  
35449

**REVISION DATE**  
20170124

**FIRMWARE**  
OEM-CH(RS)-CH5-[FLRSCH5]

**HARDWARE**  
FLRSCH5

**ACCESSORIES**  
FLPROG (REQUIRED)



**NOTICE** The manufacturer will accept no responsibility for any electrical damage resulting from improper installation of this product, be that either damage to the vehicle itself or to the installed device. This device must be installed by a certified technician. Please review the Installation Guide carefully before beginning any work.



#### BEFORE INSTALLATION

- 1- Connect module to computer
- 2- Login to Weblink account
- 3- Flash firmware to module (module is not preloaded with firmware)
- 4- Use accessories accordingly (accessories are sold separately)

MAKE	MODEL	YEAR	INSTALL TYPE	FEATURES														
				DATA IMMOBILIZER BYPASS	3X LOCK START/STANDALONE MOD.	PRIORITY UNLOCK	DOOR LOCK	DOOR UNLOCK	ARM OEM ALARM	DISARM OEM ALARM	TRUNK/HATCH RELEASE	DATA/MUX STARTER CTRL	DOOR STATUS	BRAKE PEDAL STATUS	TACHOMETER STATUS	PARKING LIGHT CTRL*	RAP SHUTDOWN CTRL	
CHRYSLER	200 AT	11-14	2	•	•	•	•	•	•	•	•	•	•	•	•	•	•	•
	300 / 300C AT	05-07	1 or 3	•	•	•	•	•	•	•	•	•	•	•	•	•	•	•
	Aspen AT	07-10	2	•	•	•	•	•	•	•	•	•	•	•	•	•	•	•
	PT Cruiser AT	06-10	1 or 3	•	•	•	•	•	•	•	•	•	•	•	•	•	•	•
	Sebring AT	07-10	2	•	•	•	•	•	•	•	•	•	•	•	•	•	•	•
DODGE	Avenger AT	08-14	2	•	•	•	•	•	•	•	•	•	•	•	•	•	•	•
	Caliber (with start wire) AT	07	1 or 3	•	•	•	•	•	•	•	•	•	•	•	•	•	•	•
	Caliber AT	07-12	2	•	•	•	•	•	•	•	•	•	•	•	•	•	•	•
	Charger AT	06-07	1 or 3	•	•	•	•	•	•	•	•	•	•	•	•	•	•	•
	Durango AT	07-10	2	•	•	•	•	•	•	•	•	•	•	•	•	•	•	•
	Magnum AT	05-07	1 or 3	•	•	•	•	•	•	•	•	•	•	•	•	•	•	•
	Nitro AT	07-11	2	•	•	•	•	•	•	•	•	•	•	•	•	•	•	•
	Ram 1500 AT	07-08	2	•	•	•	•	•	•	•	•	•	•	•	•	•	•	•
	Ram 2500 AT	07-09	2	•	•	•	•	•	•	•	•	•	•	•	•	•	•	•
	Ram 3500 AT	07-09	2	•	•	•	•	•	•	•	•	•	•	•	•	•	•	•
	Ram 3500 chassis cab AT	07-09	2	•	•	•	•	•	•	•	•	•	•	•	•	•	•	•
	Ram 4500 chassis cab AT	08-10	2	•	•	•	•	•	•	•	•	•	•	•	•	•	•	•
	Ram 5500 chassis cab AT	08-10	2	•	•	•	•	•	•	•	•	•	•	•	•	•	•	•
JEEP	Commander AT	06-07	1 or 3	•	•	•	•	•	•	•	•	•	•	•	•	•	•	•
	Compass AT	07-16	2	•	•	•	•	•	•	•	•	•	•	•	•	•	•	•
	Grand Cherokee AT	05-07	1 or 3	•	•	•	•	•	•	•	•	•	•	•	•	•	•	•
	Liberty AT	08-12	2	•	•	•	•	•	•	•	•	•	•	•	•	•	•	•
	Patriot AT	07-16	2	•	•	•	•	•	•	•	•	•	•	•	•	•	•	•
Wrangler AT	07-16	2	•	•	•	•	•	•	•	•	•	•	•	•	•	•	•	
RAM	4500 chassis cab AT	10	2	•	•	•	•	•	•	•	•	•	•	•	•	•	•	•
	5500 chassis cab AT	10	2	•	•	•	•	•	•	•	•	•	•	•	•	•	•	•

**WARNING**

I Install Type 1 requires a T-harness manufactured before 2013/11/04  
Install Type 3 requires a T-harness manufactured after 2013/11/05

\* May require additional parts.

**BOX CONTENTS**

**MODULE**

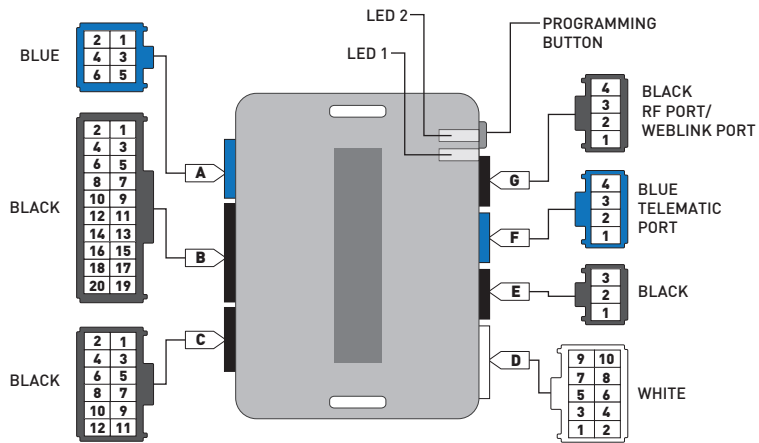

**T-HARNESS 1**

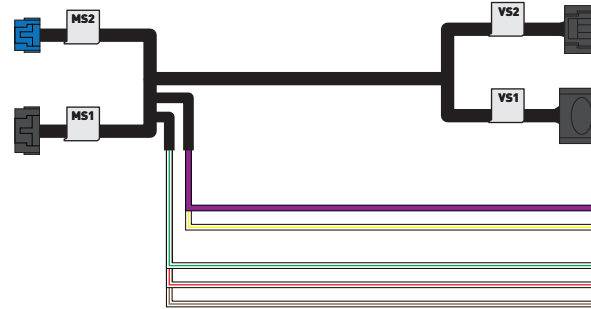

**10 PIN CONNECTOR**



**12 PIN CONNECTOR**



**AFTERMARKET HOOD SWITCH AND CABLE**



**WARNING STICKER**



**WEBLINK CABLE (required accessory sold separately)**

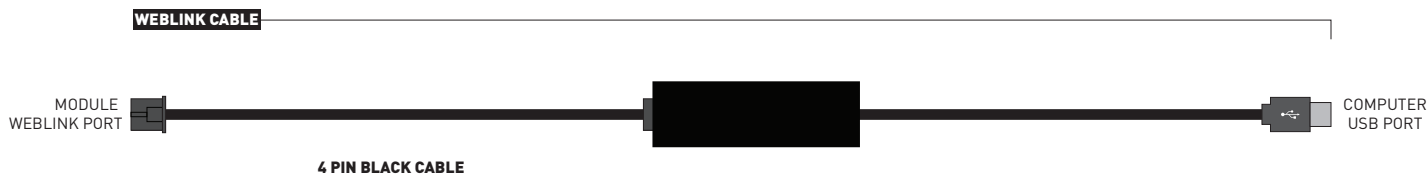

MAKE	MODEL	YEAR	WIRE DESCRIPTION	CONNECTOR NAME	CONNECTOR COLOR	CONNECTOR TYPE	POSITION	WIRE COLOR	POLARITY	MODULE LOCATION	COMPONENT LOCATOR
CHRYSLER	300/300C	05-07	Control	C1	Black	5 pin	2	Violet/Brown	(MUX)	Ignition switch	~
			Starter	C1	Black	5 pin	4	Pink/DkGreen	(+)	Ignition switch	~
			Parking Light*	~	~	~	~	White/Purple	(+)	Passenger kick panel	~
			Driver Door Pin	~	~	~	~	Purple	(-)	Driver kick panel	~
			Hood Status	~	~	~	~	Purple/LtBlue	(-)	Switch	~
	PT Cruiser	06-10	Control	C1	Black	5 pin	2	Violet/Brown	(MUX)	Ignition switch	~
			Starter	C1	Black	5 pin	4	Pink/LtBlue	(+)	Ignition switch	~
			Parking Light*	~	~	~	~	White/Purple	(+)	Driver kick panel	~
			Driver Door Pin	~	~	~	~	Purple	(-)	Driver kick panel	~
			Hood Status	~	~	~	~	Brown/Tan	(-)	Switch	~
DODGE	Caliber (with start wire)	07	Control	C1	Black	5 pin	2	Violet/Brown	(MUX)	Ignition switch	~
			Starter	C1	Black	5 pin	4	Pink/DkGreen	(+)	Ignition switch	~
			Parking Light*	~	~	~	~	White/Purple	(+)	Driver kick panel	~
			Driver Door Pin	~	~	~	~	Purple/Blue	(-)	Driver kick panel	~
			Hood Status	~	~	~	~	~	~	~	~
	Charger	06-07	Control	C1	Black	5 pin	2	Violet/Brown	(MUX)	Ignition switch	~
			Starter	C1	Black	5 pin	4	Pink/DkGreen	(+)	Ignition switch	~
			Parking Light*	~	~	~	~	White/Purple	(+)	Passenger kick panel	~
			Driver Door Pin	~	~	~	~	Purple	(-)	Driver kick panel	~
			Hood Status	~	~	~	~	Purple/LtBlue	(-)	Switch	~
	Magnum	05-07	Control	C1	Black	5 pin	2	Violet/Brown	(MUX)	Ignition switch	~
			Starter	C1	Black	5 pin	4	Pink/DkGreen	(+)	Ignition switch	~
			Parking Light*	~	~	~	~	White/Purple	(+)	Passenger kick panel	~
			Driver Door Pin	~	~	~	~	Purple	(-)	Driver kick panel	~
			Hood Status	~	~	~	~	Purple/LtBlue	(-)	Switch	~
JEEP	Commander	06-07	Control	C1	Black	5 pin	2	Violet/Brown	(MUX)	Ignition switch	~
			Starter	C1	Black	5 pin	4	Pink/Orange	(+)	Ignition switch	~
			Parking Light*	~	~	~	85	~	(-)	Parking light relay, engine compartment.	~
			Driver Door Pin	~	~	~	~	Purple	(-)	Driver kick panel	~
			Hood Status	~	~	~	~	Purple/LtBlue	(-)	Switch	~
	Grand Cherokee	05-07	Control	C1	Black	5 pin	2	Violet/Brown	(MUX)	Ignition switch	~
			Starter	C1	Black	5 pin	4	Pink/Orange	(+)	Ignition switch	~
			Parking Light*	~	~	~	~	White/Purple	(-)	Parking light relay, engine compartment.	~
			Driver Door Pin	~	~	~	~	Purple/Blue	(-)	Driver kick panel	~
			Hood Status	~	~	~	~	Purple/LtBlue	(-)	Switch	~

\* Requires additional parts.

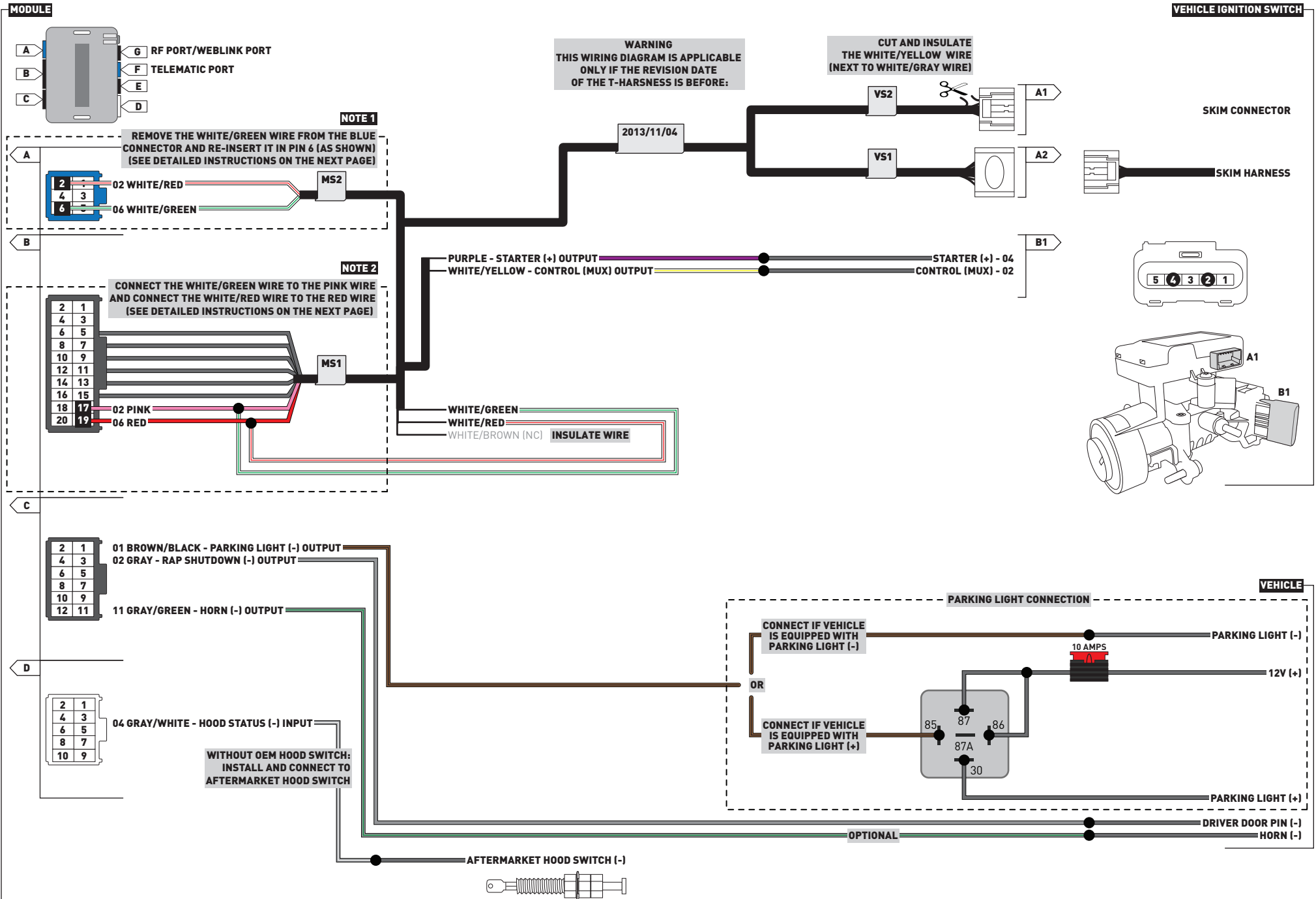

**NOTE 1**

- STEP 1:**  
 -REMOVE THE WHITE/GREEN WIRE FROM THE BLUE CONNECTOR CAREFULLY.  
 -USE A UTILITY KNIFE TO PUSH GENTLY AGAINST THE LOCKING TAB.  
 -DO NOT DAMAGE THE LOCKING TAB IN THE PROCESS.

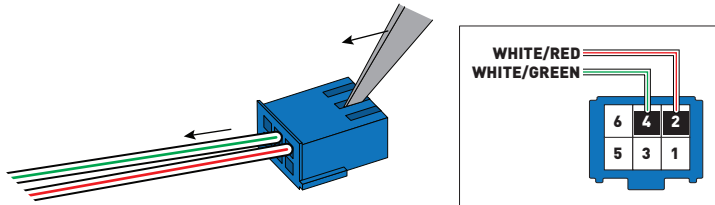

- STEP 2:**  
 -USING A UTILITY KNIFE, LIFT THE LOCKING TAB CAREFULLY FOR IT TO BE RE-USED.

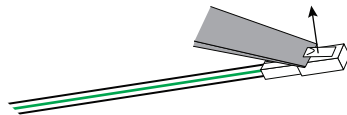

- STEP 3:**  
 -INSERT THE WIRE IN PIN 6 OF THE CONNECTOR, RIGHT NEXT TO WHERE IT USED TO BE.

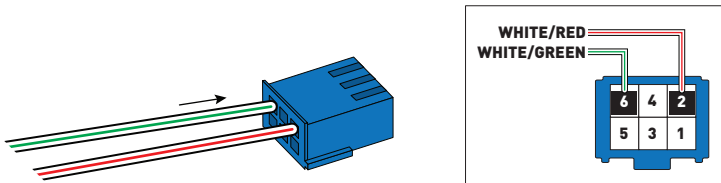

**NOTE 2**

- STEP 1:**  
 -IDENTIFY THE PINK (PIN 17) AND RED (PIN 19) WIRES FROM THE 20 PIN BLACK CONNECTOR OF THE T-HARNESS.  
 -CAREFULLY STRIP THE PINK AND RED WIRES USING A WIRE STRIPPER.  
 -DO NOT CUT THE WIRES IN THE PROCESS.

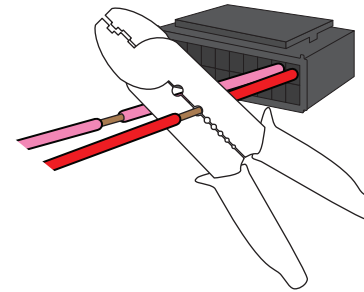

- STEP 2:**  
 -CONNECT AND SOLDER THE WHITE/RED WIRE TO THE RED WIRE.  
 -CONNECT AND SOLDER THE WHITE/GREEN WIRE TO THE PINK WIRE.

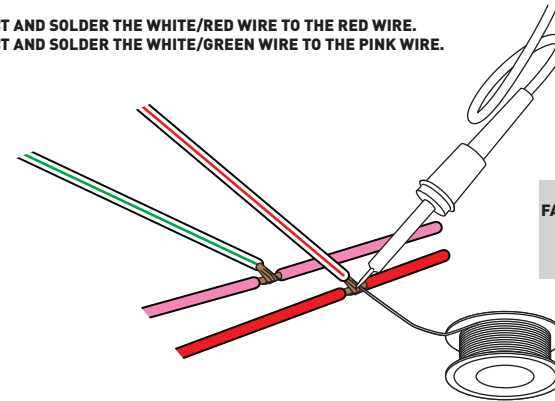

**WARNING**  
 FAILURE TO PROPERLY SOLDER  
 CAN RESULT IN  
 FAULTY CONNECTIONS AND  
 PRODUCT MALFUNCTION

- STEP 3:**  
 -INSULATE THE CONNECTIONS WITH ELECTRICAL TAPE.

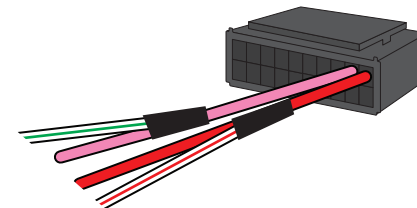

MAKE	MODEL	YEAR	WIRE DESCRIPTION	CONNECTOR NAME	CONNECTOR COLOR	CONNECTOR TYPE	POSITION	WIRE COLOR	POLARITY	MODULE LOCATION	COMPONENT LOCATOR
CHRYSLER	200	11-14	Mux	~	~	~	~	~	~	~	~
			Starter	~	~	~	~	~	~	~	~
			Parking Light*	~	~	~	~	White/Purple	(+)	Driver kick panel	~
			Driver Door Pin	~	~	~	~	Purple	(-)	Driver kick panel	~
			Hood Status	~	~	~	~	Purple/LtBlue	(-)	Switch	~
	Aspen	07-10	Mux	~	~	~	~	~	~	~	~
			Starter	~	~	~	~	~	~	~	~
			Parking Light	~	~	~	~	Pink/Red	(MUX)	Switch	~
			Driver Door Pin	~	~	~	~	Violet	(-)	Driver door module	~
			Hood Status	~	~	~	~	Purple/Blue	(-)	Switch	~
	Sebring	07-10	Mux	~	~	~	~	~	~	~	~
			Starter	~	~	~	~	~	~	~	~
			Parking Light*	~	~	~	~	White/Purple	(+)	Driver kick panel	~
			Driver Door Pin	~	~	~	~	Purple	(-)	Driver kick panel	~
			Hood Status	~	~	~	~	Purple/LtBlue	(-)	Switch	~
DODGE	Avenger	08-14	Mux	~	~	~	~	~	~	~	~
			Starter	~	~	~	~	~	~	~	~
			Parking Light*	~	~	~	~	White/Purple	(+)	Driver kick panel	~
			Driver Door Pin	~	~	~	~	Purple	(-)	Driver kick panel	~
			Hood Status	~	~	~	~	~	~	~	~
	Caliber	07-12	Mux	~	~	~	~	~	~	~	~
			Starter	~	~	~	~	~	~	~	~
			Parking Light*	~	~	~	~	White/Purple	(+)	Driver kick panel	~
			Driver Door Pin	~	~	~	~	Purple/Blue	(-)	Driver kick panel	~
			Hood Status	~	~	~	~	Purple/LtBlue	(-)	Switch	~
	Durango	07-10	Mux	~	~	~	~	~	~	~	~
			Starter	~	~	~	~	~	~	~	~
			Parking Light	~	~	~	~	Pink/Red	(MUX)	Switch	~
			Driver Door Pin	~	~	~	~	Violet	(-)	Driver door module	~
			Hood Status	~	~	~	~	Purple/LtBlue	(-)	Switch	~
DODGE	Nitro	07-11	Mux	~	~	~	~	~	~	~	~
			Starter	~	~	~	~	~	~	~	~
			Parking Light*	~	~	~	~	White/Purple + White/Green	(+)	Driver kick panel	~
			Driver Door Pin	~	~	~	~	Purple	(-)	Driver kick panel	~
			Hood Status	~	~	~	~	Purple/LtBlue	(-)	Switch	~

\* Requires additional parts.

MAKE	MODEL	YEAR	WIRE DESCRIPTION	CONNECTOR NAME	CONNECTOR COLOR	CONNECTOR TYPE	POSITION	WIRE COLOR	POLARITY	MODULE LOCATION	COMPONENT LOCATOR
DODGE	Ram 1500	07-09	Mux	~	~	~	~	~	~	~	~
			Starter	~	~	~	~	~	~	~	~
			Parking Light	~	~	~	~	White/Green	(MUX)	Switch	~
			Driver Door Pin	~	~	~	~	Purple	(-)	Driver kick panel	~
			Hood Status	~	~	~	~	Purple/LtBlue	(-)	Switch	~
	Ram 2500	07-09	Mux	~	~	~	~	~	~	~	~
			Starter	~	~	~	~	~	~	~	~
			Parking Light	~	~	~	~	White/Green	(MUX)	Switch	~
			Driver Door Pin	~	~	~	~	Purple	(-)	Driver kick panel	~
			Hood Status	~	~	~	~	Purple/LtBlue	(-)	Switch	~
	Ram 3500	07-09	Mux	~	~	~	~	~	~	~	~
			Starter	~	~	~	~	~	~	~	~
			Parking Light	~	~	~	~	White/Green	(MUX)	Switch	~
			Driver Door Pin	~	~	~	~	Purple	(-)	Driver kick panel	~
			Hood Status	~	~	~	~	Purple/LtBlue	(-)	Switch	~
	Ram 4500	08-10	Mux	~	~	~	~	~	~	~	~
			Starter	~	~	~	~	~	~	~	~
			Parking Light	~	~	~	~	White/Green	(MUX)	Switch	~
			Driver Door Pin	~	~	~	~	Purple	(-)	Driver kick panel	~
			Hood Status	~	~	~	~	Purple/LtBlue	(-)	Switch	~
Ram 5500	08-10	Mux	~	~	~	~	~	~	~	~	
		Starter	~	~	~	~	~	~	~	~	
		Parking Light	~	~	~	~	White/Green	(MUX)	Switch	~	
		Driver Door Pin	~	~	~	~	Purple	(-)	Driver kick panel	~	
		Hood Status	~	~	~	~	Purple/LtBlue	(-)	Switch	~	
JEEP	Compass	07-16	Mux	~	~	~	~	~	~	~	~
			Starter	~	~	~	~	~	~	~	~
			Parking Light*	~	~	~	~	White/Purple	(+)	Driver kick panel	~
			Driver Door Pin	~	~	~	~	Purple/Blue	(-)	Driver kick panel	~
			Hood Status	~	~	~	~	Purple/Blue	(-)	Switch	~
	Liberty	08-12	Mux	~	~	~	~	~	~	~	~
			Starter	~	~	~	~	~	~	~	~
			Parking Light*	~	~	~	~	White/Purple	(+)	Driver kick panel	~
			Driver Door Pin	~	~	~	~	Purple	(-)	Driver kick panel	~
			Hood Status	~	~	~	~	Purple/LtBlue	(-)	Switch	~

\* Requires additional parts.



MAKE	MODEL	YEAR	WIRE DESCRIPTION	CONNECTOR NAME	CONNECTOR COLOR	CONNECTOR TYPE	POSITION	WIRE COLOR	POLARITY	MODULE LOCATION	COMPONENT LOCATOR
JEEP	Patriot	07-16	Mux	~	~	~	~	~	~	~	~
			Starter	~	~	~	~	~	~	~	~
			Parking Light*	~	~	~	~	White/Purple	(+)	Driver kick panel	~
			Driver Door Pin	~	~	~	~	Purple/Blue	(-)	Driver kick panel	~
			Hood Status	~	~	~	~	~	~	~	~
	Wrangler	07-16	Mux	~	~	~	~	~	~	~	~
			Starter	~	~	~	~	~	~	~	~
			Parking Light*	~	~	~	~	White/Purple + White/Orange	(+)	Passenger kick pad	~
			Driver Door Pin	~	~	~	~	Purple	(-)	Driver kick panel	~
			Hood Status	~	~	~	~	Purple/LtBlue	(-)	Switch	~
RAM	4500	10	Mux	~	~	~	~	~	~	~	~
			Starter	~	~	~	~	~	~	~	~
			Parking Light	~	~	~	~	White/Green	(MUX)	Switch	~
			Driver Door Pin	~	~	~	~	Purple	(-)	Driver kick panel	~
			Hood Status	~	~	~	~	Purple/LtBlue	(-)	Switch	~
	5500	10	Mux	~	~	~	~	~	~	~	~
			Starter	~	~	~	~	~	~	~	~
			Parking Light	~	~	~	~	White/Green	(MUX)	Switch	~
			Driver Door Pin	~	~	~	~	Purple	(-)	Driver kick panel	~
			Hood Status	~	~	~	~	Purple/LtBlue	(-)	Switch	~

\* Requires additional parts.

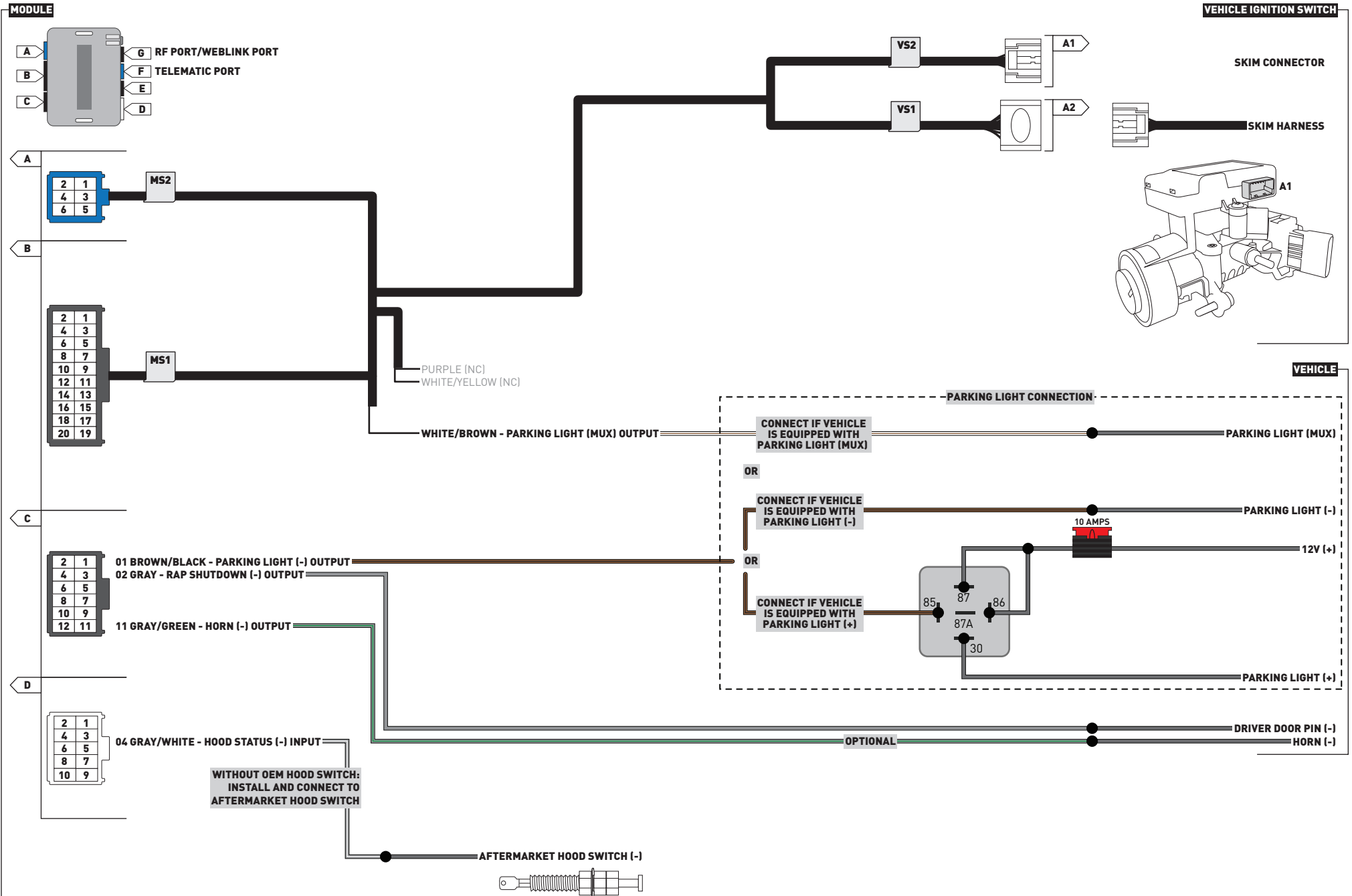

MAKE	MODEL	YEAR	WIRE DESCRIPTION	CONNECTOR NAME	CONNECTOR COLOR	CONNECTOR TYPE	POSITION	WIRE COLOR	POLARITY	MODULE LOCATION	COMPONENT LOCATOR
CHRYSLER	300/300C	05-07	Control	C1	Black	5 pin	2	Violet/Brown	(MUX)	Ignition switch	~
			Starter	C1	Black	5 pin	4	Pink/DkGreen	(+)	Ignition switch	~
			Parking Light*	~	~	~	~	White/Purple	(+)	Passenger kick panel	~
			Driver Door Pin	~	~	~	~	Purple	(-)	Driver kick panel	~
			Hood Status	~	~	~	~	Purple/LtBlue	(-)	Switch	~
	PT Cruiser	06-10	Control	C1	Black	5 pin	2	Violet/Brown	(MUX)	Ignition switch	~
			Starter	C1	Black	5 pin	4	Pink/LtBlue	(+)	Ignition switch	~
			Parking Light*	~	~	~	~	White/Purple	(+)	Driver kick panel	~
			Driver Door Pin	~	~	~	~	Purple	(-)	Driver kick panel	~
			Hood Status	~	~	~	~	Brown/Tan	(-)	Switch	~
DODGE	Caliber (with start wire)	07	Control	C1	Black	5 pin	2	Violet/Brown	(MUX)	Ignition switch	~
			Starter	C1	Black	5 pin	4	Pink/DkGreen	(+)	Ignition switch	~
			Parking Light*	~	~	~	~	White/Purple	(+)	Driver kick panel	~
			Driver Door Pin	~	~	~	~	Purple/Blue	(-)	Driver kick panel	~
			Hood Status	~	~	~	~	~	~	~	~
	Charger	06-07	Control	C1	Black	5 pin	2	Violet/Brown	(MUX)	Ignition switch	~
			Starter	C1	Black	5 pin	4	Pink/DkGreen	(+)	Ignition switch	~
			Parking Light*	~	~	~	~	White/Purple	(+)	Passenger kick panel	~
			Driver Door Pin	~	~	~	~	Purple	(-)	Driver kick panel	~
			Hood Status	~	~	~	~	Purple/LtBlue	(-)	Switch	~
	Magnum	05-07	Control	C1	Black	5 pin	2	Violet/Brown	(MUX)	Ignition switch	~
			Starter	C1	Black	5 pin	4	Pink/DkGreen	(+)	Ignition switch	~
			Parking Light*	~	~	~	~	White/Purple	(+)	Passenger kick panel	~
			Driver Door Pin	~	~	~	~	Purple	(-)	Driver kick panel	~
			Hood Status	~	~	~	~	Purple/LtBlue	(-)	Switch	~
JEEP	Commander	06-07	Control	C1	Black	5 pin	2	Violet/Brown	(MUX)	Ignition switch	~
			Starter	C1	Black	5 pin	4	Pink/Orange	(+)	Ignition switch	~
			Parking Light*	~	~	~	85	~	(-)	Parking light relay, engine compartment.	~
			Driver Door Pin	~	~	~	~	Purple	(-)	Driver kick panel	~
			Hood Status	~	~	~	~	Purple/LtBlue	(-)	Switch	~
	Grand Cherokee	05-07	Control	C1	Black	5 pin	2	Violet/Brown	(MUX)	Ignition switch	~
			Starter	C1	Black	5 pin	4	Pink/Orange	(+)	Ignition switch	~
			Parking Light*	~	~	~	~	White/Purple	(-)	Parking light relay, engine compartment.	~
			Driver Door Pin	~	~	~	~	Purple/Blue	(-)	Driver kick panel	~
			Hood Status	~	~	~	~	Purple/LtBlue	(-)	Switch	~

\* Requires additional parts.



01 Close driver door.



02 Re-open driver door to wake up data bus.



03 Insert key into ignition.



04 Turn key to ON position.



05 LED will turn solid RED.

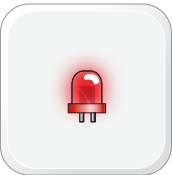

06 Within 5 seconds, LED will flash GREEN rapidly.



07 Turn key to OFF position.



08 Remove key.



09 Press UNLOCK on the OEM remote. If vehicle is not equipped with OEM remote, press module programming button.



10 Wait, LED will turn solid GREEN for 2 seconds.



11 Module Programming Procedure completed.



>>



NOTE: In Valet Mode, the Remote starter is not functional. Keyless entry, Lock and Unlock will remain functional. See RF kit user manual for alternate valet mode programming.

01



Time restriction. Complete next step within 7 seconds.

02



Cycle ignition ON five times [5x OFF/ON] rapidly.

03



Wait, LED 1 will turn solid RED for 2 seconds.

04



Set ignition to OFF position.

05





Valet Mode Programming Procedure completed.

>>



To exit valet mode: repeat steps 1 to 5.

>>  It is mandatory to exit the Module Navigation at the end of this procedure. Failure to exit the Module Navigation will drain vehicle battery. To exit the Module Navigation at any time: Follow STEP 13.

>>  Module must be programmed to the vehicle.

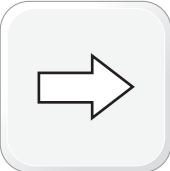
>>  Use the Module Navigation Chart on the next page.

01  Set ignition to OFF position.

02  TO ACCESS THE MENUS: Press and hold programming button until LED 1 turns solid GREEN.

03  IN THE MENUS: Press the programming button as many times as the menu number indicates. LED 1 will flash GREEN an equal amount of times continuously.

04  TO ACCESS THE OPTIONS: Press and hold programming button until LED 1 turns solid RED.

05  IN THE OPTIONS: Press the programming button as many times as the option number indicates. LED 1 will flash RED an equal amount of times continuously.

06  TO ACCESS THE SETTINGS: Press and hold programming button until LED 1 turns solid GREEN.

07  LED 1 will flash GREEN as many times as the current (or default) setting number, continuously.

08  IN THE SETTINGS: Press the programming button as many times as necessary to access your setting. LED 1 will flash GREEN an equal amount of times continuously.

09  To return to the MENUS: exit the Module Navigation and redo the Module Navigation Procedure.

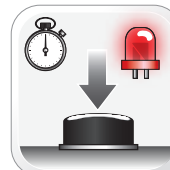
10  To save and return to the OPTIONS: Press and hold programming button until LED 1 turns solid RED.

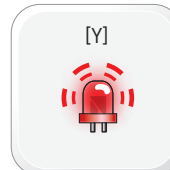
11  LED 1 will flash RED as many times as the current option number continuously.

12  Configure every other setting and proceed to step 13.

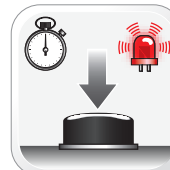
13  MANDATORY: EXIT MODULE NAVIGATION. Press and hold programming button for 7 seconds. LED 1 will flash RED rapidly. Release programming button. LED 1 will turn OFF.

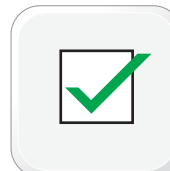
14  Module navigation completed.

>>  Failure to exit the Module Navigation will drain vehicle battery.

MODULE NAVIGATION CHART: NOTES	[X] MENUS		[Y] OPTIONS	[Z] SETTINGS
I Default settings are listed in bold. II Make sure the option is covered on the vehicle before attempting to change the setting.	01	CONFIGURATION	01 DISARM/UNLOCK BEFORE START	01 <b>OFF</b> 02 ON
			02 RELOCK AFTER START	01 <b>OFF</b> 02 ON
			03 RELOCK AFTER SHUTDOWN	01 <b>OFF</b> 02 ON
			04 FORCE UNLOCK ALL ON FIRST PRESS	01 <b>OFF</b> 02 ON
			05 TAKEOVER	01 <b>ENABLE</b> 02 DISABLE*
			06 N/A	01 N/A
			07 FACTORY KEYLESS RS SEQUENCE	01 DISABLE 02 N/A 03 LOCK + UNLOCK + LOCK 04 <b>LOCK + LOCK + LOCK</b>
			08 MODULE RUN TIME	01 03 MIN 02 05 MIN 03 10 MIN 04 15 MIN 05 25 MIN 06 30 MIN 07 35 MIN 08 <b>15 MIN</b>
			09 WAIT TO START DELAY	01 <b>02 SEC</b> 02 05 SEC 03 08 SEC 04 10 SEC 05 15 SEC 06 20 SEC 07 25 SEC 08 30 SEC
			10 N/A	01 N/A
			11 N/A	01 N/A
			12 N/A	01 N/A
			13 N/A	01 N/A

\*Vehicle will shutdown when a door is opened.



MODULE NAVIGATION CHART: NOTES		[X] MENUS	[Y] OPTIONS	[Z] SETTINGS	
	01	CONFIGURATION	14	HORN EVENT TRIGGER	01 <b>DOUBLE LOCK</b>
				02 LOCK + UNLOCK	
			03 LOCK + UNLOCK + START		
			04 DOUBLE LOCK + START		
	15	HORN CHIRPS WIDTH	01 <b>30 mSEC</b>		
			02 15 mSec		
03 60 mSec					
02-07	Technical Support only	01 N/A	01 N/A		

\*Vehicle will shutdown when a door is opened.

REMOTE STARTER ERROR CODES: NOTES	[X] NUMBER OF PARKING LIGHT FLASHES	DIAGNOSTIC
I WARNING: The following applies only when the parking lights are connected and supported by the system.	03	Foot brake is ON.
	04	Hood is open.
II After a remote starter failure, the parking lights will flash [X] number times to indicate an error code. See table.	05	Engine tach signal is lost.
	06	System is in Valet Mode.
	07	Vehicle is moving (VSS).
	08	Glow plug timeout error.
	09	RS not synchronized. Start vehicle with OEM key for 15 sec before trying a new RS sequence.
	10	N/A
	11	N/A
	12	N/A
	13	N/A
	14	N/A
	15	N/A
	16	CAN communication failure during RS sequence.

TEST MODULE		LED 1 STATUS	DIAGNOSTIC
I	DURING PROGRAMMING	Flashing RED	Missing/wrong information from firmware or vehicle.
		Solid RED	Module waiting for more vehicle information.
		Flashing GREEN	Additional steps required to complete module programming.
		Solid GREEN then OFF	Module correctly programmed.
		OFF	No activity or module already programmed.
II	DURING REMOTE START	Flashing RED	Module incorrectly programmed.
		Solid RED	Module incorrectly programmed.
		Flashing GREEN	Module correctly programmed and operational.
		Solid GREEN then OFF	Reset in progress.
		OFF	Invalid ground when running status from remote starter.
III	WITH IGNITION OFF	Flashing RED	Module incorrectly programmed or connected.
		Solid RED	Module not programmed. Waiting for more vehicle information.
		Flashing GREEN	False ground when running status from remote starter.
		Solid GREEN then OFF	Reset in progress.
		OFF	Module at rest and ready for a remote start sequence.

**01** Disconnect all connectors from module except the BLACK 20-PIN connector.

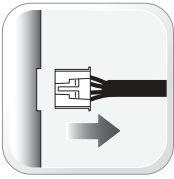

**02** Disconnect the BLACK 20-PIN connector.

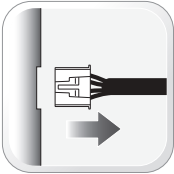

**03** PRESS AND HOLD the module's programming button while connecting the BLACK 20-PIN connector.



**04** Wait, LED 1 will flash RED. RELEASE programming button.



**05** LED 1 will turn RED for 2 seconds.

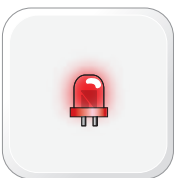

**06** Module RESET completed.



**07** Reconnect all connectors.

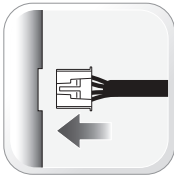

**08** Repeat programming procedure.



**>>** Failure to follow procedure may result with a DTC or a CHECK ENGINE error message.



>>



All vehicle doors must be closed and locked prior to remote start sequence.

01



Press unlock on OEM or aftermarket remote.

02



Insert key into ignition.

03



Turn key to ON position.

04



Press and release BRAKE pedal.

05



Take over procedure completed.

>>



Failure to follow procedure will result in vehicle engine shutdown.

CHECKLIST	
1	WARNING: Vehicle engine will start many times. Test in a well ventilated area.
2	Close all vehicle doors, hood and trunk.
3	Press LOCK button three times [3x] rapidly on the OEM keyfob to remote start vehicle.
	<b>Question 1:</b> Does the vehicle remote start?
<input type="checkbox"/>	YES: Go to next step.
<input type="checkbox"/>	NO: The module doesn't detect OEM remote lock button from the vehicle communication network. Check all connections, repeat the test and call technical support, if the problem persists.
4	Press LOCK button three times [3x] rapidly on the OEM keyfob to shut down vehicle.
	<b>Question 2:</b> Does the vehicle shut down?
<input type="checkbox"/>	YES: Go to next step.
<input type="checkbox"/>	NO: Repeat step. If the problem persists, press on the brake pedal once [1x] to shut down the vehicle and call technical support.
5	RAP Shutdown test
	<b>Question 3:</b> Did the radio, interior controls, and headlights turn off within 60 seconds after remote start shutdown?
<input type="checkbox"/>	YES: Go to next step.
<input type="checkbox"/>	NO: Verify the RAP SHUTDOWN connections as illustrated in the wiring diagram. Repeat the test and call technical support, if the problem persists.
6	Open hood.
7	If not already installed, affix the mandatory orange warning sticker under the hood and proceed to next step.
8	Press LOCK button three times [3x] rapidly on the OEM keyfob to remote start vehicle.
	<b>Question 4:</b> Does the vehicle remote start?
<input type="checkbox"/>	YES: The vehicle is not equipped with a factory hood pin. Install a mandatory aftermarket hood switch, then repeat the test.
<input type="checkbox"/>	NO: Go to next step.
9	Close hood.
10	Enter vehicle and close the doors.
11	Press LOCK button three times [3x] rapidly on the OEM keyfob to remote start vehicle.
12	Wait for the vehicle to start.
13	Press brake pedal.
	<b>Question 5:</b> Does the vehicle shut down?
<input type="checkbox"/>	YES: Go to next step.
<input type="checkbox"/>	NO: The module does NOT detect the brake pedal signal. Press LOCK button three times [3x] rapidly on the OEM keyfob to shut down, check the brake connection as illustrated in the wiring diagram, if applicable, and call technical support.
14	Exit vehicle.
15	Installation checklist completed.